

**Download Solved Mid/Final Term
Past Papers by Waqar Siddhu
in PDF form**

VUNET.BLOGSPOT.COM



Facebook.com/vunets



An optimization problem is one in which you want to find,

moaaz

Answer (Please select your correct option)

VuAnswers.com

Not a solution

An algorithm

Good solution

The best solution

correct

Made by: Waqar Siddhu

Suppose that a graph $G = (V, E)$ is implemented using adjacency lists. What is the complexity of a breadth-first traversal of G ?

page 116

VuAnswers.com

Answer (Please select your correct option)

$O(|V|^2)$

$O(|V| + |E|)$

$O(|V|^2|E|)$

$O(|V| + |E|)$

correct

Made by: Waqar Siddhu

The total degrees of the graph is

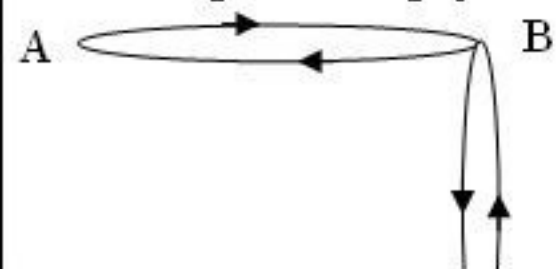

Answer (Please select your correct option)

VuAnswers.com

3

5

6

9

Made by: Waqar Siddhu



Answer (Please select your correct option)

VuAnswers.com

3

5

6

9

Made by: Waqar Siddhu



Answer (Please select your correct option)

VuAnswers.com

 3 5 6 9**Made by: Waqar Siddhu**

Non-optimal or greedy algorithm for money change takes _____

Answer (Please select your correct option)

VuAnswers.com

$O(k)$

correct

$O(2^k)$

$O(N)$

$O(kN)$

Made by: Waqar Siddhu

The Huffman algorithm finds a (n) _____ solution.

102

VuAnswers.com

Answer (Please select your correct option)

Optimal

correct

Non-optimal

Exponential

Polynomial

Made by: Waqar Siddhu

Which formula is used for calculating worst case running time?

Answer (Please select your correct option)

VuAnswers.com

$T_{worst}(n) = \max_{|I|=n} T(I)$

correct

$T_{worst}(n) = \max_{|I|=1} T(I)$

$T_{worst}(n) = \max_{|I|=1} T(n)$

$T_{worst}(n) = \max_{|I|=n} T(n)$

Made by: Waqar Siddhu

The reason for introducing Sieve Technique algorithm is that it illustrates a very important special case of,

34

Answer (Please select your correct option)

VuAnswers.com

divide-and-conquer

correct

decrease and conquer

greedy nature

2-dimension Maxima

Made by: Waqar Siddhu

Sieve Technique applies to problems where we are interested in finding a single item from a larger set of _____

34

VuAnswers.com

Answer (Please select your correct option)

n items

correct

phases

pointers

constant

Made by: Waqar Siddhu

The number of nodes in a complete binary tree of height h is

VuAnswers.com

Answer (Please select your correct option)

$2^{(h+1)} - 1$

correct

$2 * (h+1) - 1$

$2 * (h+1)$

$((h+1)^2) - 1$

Made by: Waqar Siddhu

If there are $\Theta(n^2)$ entries in edit distance matrix then the total running time is

Answer (Please select your correct option)

VuAnswers.com

$\Theta(1)$

$\Theta(n^2)$

correct

$\Theta(n)$

$\Theta(n \log n)$

Made by: Waqar Siddhu

When a recursive algorithm revisits the same problem over and over again, we say that the optimization problem has _____ sub-problems.

Answer (Please select your correct option)

VuAnswers.com

Overlapping

correct

Over costing

Optimized

None of these

Made by: Waqar Siddhu

A $p \times q$ matrix A can be multiplied with a $q \times r$ matrix B . The result will be a $p \times r$ matrix C . There are $(p \cdot r)$ total entries in C and each takes _____ to compute.

Answer (Please select your correct option)

VuAnswers.com

(q)

correct

(1)

(n^2)

(n^3)

Made by: Waqar Siddhu

Matrix – Chain – Order is _____ than the exponential time method of enumerating all possible parenthesizations and checking each one.

Answer (Please select your correct option)

VuAnswers.com

Much more efficient

Only fractional efficient

Worst

Too slow

Made by: Waqar Siddhu

The recurrence relation of Tower of Hanoi is given below

$$T(n) = \begin{cases} 1 & \text{if } n=1 \\ 2T(n-1)+1 & \text{if } n>1 \end{cases}$$

In order to move a tower of 4 rings from one peg to another, how many ring moves are required?

Answer (Please select your correct option)

VuAnswers.com

15

7

12

32

correct

Made by: Waqar Siddhu

Maximum number of edges in a Directed Graph may be

VuAnswers.com

Answer (Please select your correct option)

V

2V

Approximately $|V|^2$

correct

\sqrt{V}

Made by: Waqar Siddhu

An adjacency matrix for a graph

VuAnswers.com

Answer (Please select your correct option)

always square in shape

It is not necessary for it to be square in shape

correct

Is square in shape for directed graphs but not for undirected graphs

Is always diagonal matrix

Made by: Waqar Siddhu

Using ASCII standard the string "ab-#\$c" will be encoded _____ bytes

Answer (Please select your correct option)

VuAnswers.com

16

7

6

This string cannot be stored using ASCII standard

correct

Made by: Waqar Siddhu

Using Huffman encoding technique the string "a@\$a" will be encoded with _____ bits

Answer (Please select your correct option)

VuAnswers.com

5

6

8

Huffman encoding fail at this string

correct

Made by: Waqar Siddhu

In fractional knapsack we sort the

Answer (Please select your correct option)

VuAnswers.com

Value per unit weight in decreasing order

correct

Weight per unit value in decreasing order

Value per unit weight in increasing order

Weight per unit value in increasing order

Made by: Waqar Siddhu

The greedy part of the Huffman encoding algorithm is to first find two nodes with _____ frequency.

Answer (Please select your correct option)

VuAnswers.com

Larger

Smallest

correct

Balance

Character

Made by: Waqar Siddhu

The codeword assigned to characters by the Huffman algorithm have the property

Answer (Please select your correct option)

VuAnswers.com

that no codeword is the prefix of any other

correct

that no codeword is the postfix of any other

that no codeword is the infix of any other

that no codeword is neither prefix nor postfix of any other

Made by: Waqar Siddhu

In undirected graphs there

130

VuAnswers.com

Answer (Please select your correct option)

are no Cross edges but have forward and back edges

are only forward edges

is convention of only back edges

correct

is convention of forward edges

Made by: Waqar Siddhu

In time stamp DFS for the edge (u,v) if $f(u) > f(v)$ then

130

VuAnswers.com

Answer (Please select your correct option)

the edge is cross

the edge is back

the edge is forward

the edge is tree or cross or forward

correct

Made by: Waqar Siddhu

Kruskal's algorithm

Answer (Please select your correct option)

VuAnswers.com

Choose the best non-cycle edge

correct

Choose the best tree edge

Choose the vertex that gives the lightest weight

Follow the dynamic programming rules for choosing edges

Made by: Waqar Siddhu

In Prim's algorithm we use

Answer (Please select your correct option)

VuAnswers.com

Queue data structure

Priority Queue data structure

correct

Stack data structure

Both stack and Queue data structures

Made by: Waqar Siddhu

Adding any edge to a free tree

142

VuAnswers.com

Answer (Please select your correct option)

keeps it the free tree and increases the size of the tree

creates a unique cycle

correct

it is not allowed to add the edge in free tree

creates multiple cycles

Made by: Waqar Siddhu

Floyd-Warshall algorithm is

161

VuAnswers.com

Answer (Please select your correct option)

based on greedy approach and allow negative edges

based on divide and conquer approach and allow negative edges

based on dynamic programming approach and allow negative cycles

based on dynamic programming approach and allow negative edges

correct

Made by: Waqar Siddhu

Dijkstra's algorithm is used for

154

VuAnswers.com

Answer (Please select your correct option)

calculating multiple source shortest path problems

calculating Minimum spanning tree

shortest and Minimum Spanning tree both can be calculated by it

single source shortest path problems

correct

Made by: Waqar Siddhu

Bellman Ford algorithm applies relaxation to every

160

VuAnswers.com

Answer (Please select your correct option)

edge of the graph and repeats exactly $v-1$ times

correct

vertex of the graph and repeats exactly $E-1$ times

edge of the graph and repeats exactly $E-1$ times

edge but use the back edges for the completion

Made by: Waqar Siddhu

Complexity wise the comparison based merge and quick sort algorithms fall in

Answer (Please select your correct option)

VuAnswers.com

Deterministic Polynomial class

Non-Deterministic Polynomial class

Quick sort in P class and Merge sort in NP class

Quick sort in NP class and Merge sort in P class

Made by: Waqar Siddhu

Running time of Floyd-Warshall algorithm is

161

VuAnswers.com

Answer (Please select your correct option)

$\Theta(n^2)$

$\Theta(n^4)$

$\Theta(n^3)$

correct

$\Theta(3^n)$

Made by: Waqar Siddhu

If we can solve a single NP problem in P time

173

Answer (Please select your correct option)

VuAnswers.com

All NP-problems can be solved

correct

All P problems can be solved

We cannot predict about the solution of other NP problems

This can be never possible to solve the NP problem in P time

Made by: Waqar Siddhu

If a problem is NP-complete

Answer (Please select your correct option)

VuAnswers.com

it must be in P

it must also be in NP

correct

there is no relation between NP and NP-complete

it can be solved in P time

Made by: Waqar Siddhu

3-color problem is known as _____

173

VuAnswers.com

Answer (Please select your correct option)

P



NPC



correct

Co-NP



P and NP



Made by: Waqar Siddhu

Clique cover problem arises in applications of _____.

176

VuAnswers.com

Answer (Please select your correct option)

Map drawing

Clustering

correct

Architectural design

Clique

Made by: Waqar Siddhu

In the 3-coloring problem, for two vertices to be in the same group, they must be not _____ to each other.

176

VuAnswers.com

Answer (Please select your correct option)

Apart from

Far from

Near to

Adjacent to

correct

Made by: Waqar Siddhu

What is the worst-case time for merge sort to sort an array of n elements?

Answer (Please select your correct option)

VuAnswers.com

$O(n \log n)$

correct

$O(n^2)$

$O(\log n)$

$O(n)$

Made by: Waqar Siddhu

Search techniques of various algorithms look at _____

97

VuAnswers.com

Answer (Please select your correct option)

Many possible solutions

correct

Maximum 2 possible solutions

Minimum 2 possible solutions

Sorting solutions

Made by: Waqar Siddhu

The Huffman encoding algorithm is a _____

99

VuAnswers.com

Answer (Please select your correct option)

Dynamic and greedy algorithm

Divide and conquer and greedy algorithm

Geedy algorithm.

correct

Dynamic programming algorithm

Made by: Waqar Siddhu

Breadth first search is shortest path algorithm that works

153

VuAnswers.com

Answer (Please select your correct option)

on un-weighted graphs

correct

on weighted graphs

on both weighted and un-weighted graphs

BFS cannot be used for shortest path problems

Made by: Waqar Siddhu

Consider the following Huffman Tree

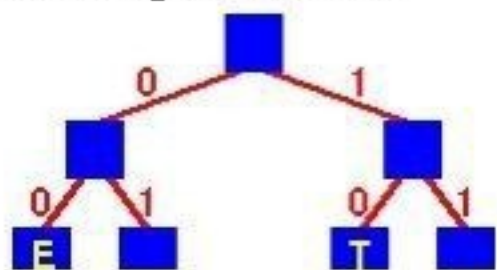

Answer (Please select your correct option)

VuAnswers.com

10 00 010

correct

011 00 010

10 00 110

11 10 110

Made by: Waqar Siddhu

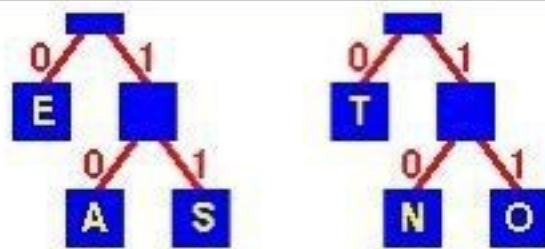

The binary code for the string "TEA" is

Answer (Please select your correct option)

VuAnswers.com

10 00 010

correct

011 00 010

10 00 110

11 10 110

Made by: Waqar Siddhu

Total running time of BFS is

Answer (Please select your correct option)

VuAnswers.com

$O(V + E)$

correct

$O(V - E)$

$O(VE)$

None of these

Made by: Waqar Siddhu

Total running time of BFS is

Answer (Please select your correct option)

VuAnswers.com

$O(V + E)$

correct

$O(V - E)$

$O(VE)$

None of these

Made by: Waqar Siddhu

Using ASCII standard the string "abacdaacac" will be encoded with _____ bits.

Answer (Please select your correct option)

VuAnswers.com

80

correct

160

320

100

Made by: Waqar Siddhu

Consider the string "abacdaacac" if the string is coded with ASCII codes using Huffman encoding scheme, the message length would be

Answer (Please select your correct option)

VuAnswers.com

8 bits

80 bits

correct

Less than 50 bits

More than 50 bits

Made by: Waqar Siddhu

What is the asymptotic growth of $\frac{4n^3 + 15n^2 + 11n}{6}$?

Answer (Please select your correct option)

VuAnswers.com

$\Theta\left(\frac{4n^3 + 15n^2 + 11n}{6}\right)$

$\Theta(4n^3 + 15n^2 + 11n)$

$\Theta(15n^2)$

correct

$\Theta(n^3)$

Made by: Waqar Siddhu

The reason for introducing Sieve Technique algorithm is that it illustrates a very important special case of,

Answer (Please select your correct option)

VuAnswers.com

divide-and-conquer

correct

decrease and conquer

greedy nature

2-dimension Maxima

Made by: Waqar Siddhu

Sieve Technique applies to problems where we are interested in finding a single item from a larger set of _____

Answer (Please select your correct option)

VuAnswers.com

n items

correct

phases

pointers

constant

Made by: Waqar Siddhu

A *heap* is a left-complete binary tree that conforms to the _____

Answer (Please select your correct option)

VuAnswers.com

(log n) order

increasing order only

decreasing order only

heap order

correct

Made by: Waqar Siddhu

What is common between Bubble sort, Insertion sort, Selection sort, Quick sort, and Heap sort?

Answer (Please select your correct option)

VuAnswers.com

All are in-place algorithms

correct

All are stable algorithms

None of these

All are unstable algorithms

Made by: Waqar Siddhu

In in-place sorting algorithm is one that uses no _____ arrays for storage.

Answer (Please select your correct option)

VuAnswers.com

two dimensional

three dimensional

n dimensional

additional

correct

Made by: Waqar Siddhu

The main shortcoming of counting sort is that it is useful for

Answer (Please select your correct option)

VuAnswers.com

Small Integers

correct

Small characters

Floats

None of these

Made by: Waqar Siddhu

The original recursive algorithm takes $\Theta(\Phi^n)$ time, where

Answer (Please select your correct option)

VuAnswers.com

$\Phi = 1.618$

correct

$\Phi = 3.142$

$\Phi = 1.816$

$\Phi = 1.168$

Made by: Waqar Siddhu

Maximum number of edges in a Directed Graph may be

Answer (Please select your correct option)

VuAnswers.com

- V
- $2V$
- Approximately $|V^2|$
correct
- \sqrt{V}

Made by: Waqar Siddhu

The Huffman algorithm finds

Answer (Please select your correct option)

VuAnswers.com

sometime optimal some time non optimal solution

space wise optimal and time wise non optimal solution

a non-optimal solution

an optimal solution

correct

Made by: Waqar Siddhu

The Huffman codes provide a method of encoding data which

Answer (Please select your correct option)

VuAnswers.com

- is efficient and use a variable length codes
- is efficient and use fixed length codes i.e. ASCII
- is efficient and both ways of variable and fixed length codes can be used
- is efficient time wise but not space wise

correct

Made by: Waqar Siddhu

Using ASCII standard the string "abacdaacac" will be encoded with _____ bytes.

Answer (Please select your correct option)

VuAnswers.com

10

16

32

8

correct

Made by: Waqar Siddhu

In fractional knapsack we sort the

Answer (Please select your correct option)

VuAnswers.com

Value per unit weight in decreasing order

Weight per unit value in decreasing order

correct

Value per unit weight in increasing order

Weight per unit value in increasing order

Made by: Waqar Siddhu

The greedy part of the Huffman encoding algorithm is to first find two nodes with _____ frequency.

Answer (Please select your correct option)

VuAnswers.com

Larger

Smallest

Balance

Character

correct

100

Made by: Waqar Siddhu

In directed graphs the cardinality of edges $|E| =$

no idea

Answer (Please select your correct option)

VuAnswers.com

Sum of out-degrees of all the vertices

Sum of in-degrees of all the vertices

First both are true

There is no relation between degree of vertices and no of edges

Made by: Waqar Siddhu

The codeword assigned to characters by the Huffman algorithm have the property

Answer (Please select your correct option)

VuAnswers.com

that no codeword is the prefix of any other

correct

that no codeword is the postfix of any other

that no codeword is the infix of any other

that no codeword is neither prefix nor postfix of any other

Made by: Waqar Siddhu

In undirected graphs there

For undirected graphs, there is no distinction between forward and back edges. By convention they are all called back edges. Furthermore, there are no cross edges (can you see why not?)

Answer (Please select your correct option)

VuAnswers.com

are no Cross edges but have forward and back edges

are only forward edges

is convention of only back edges

correct

is convention of forward edges

Made by: Waqar Siddhu

In time stamp traversal we can calculate

Answer (Please select your correct option)

VuAnswers.com

whether the graph has Cycles

correct

130 pag

total number of cycles on the bases of forward edges

total number of cycles on the bases if back edges

total no of paths of certain length

Made by: Waqar Siddhu

In time stamp DFS for the edge (u,v) if $f(u) > f(v)$ then

If this edge is a tree, forward or cross edge, then $f[u] > f[v]$.

130 page

Answer (Please select your correct option)

VuAnswers.com

the edge is cross

the edge is back

the edge is forward

the edge is tree or cross or forward

correct

Made by: Waqar Siddhu

Precedence constraint graph is

131 page

Answer (Please select your correct option)

VuAnswers.com

non acyclic directed graph

acyclic undirected graph

non acyclic undirected graph

acyclic directed graph

correct

Made by: Waqar Siddhu

In Prim's algorithm, the additional information maintained by the algorithm is

Answer (Please select your correct option)

VuAnswers.com

the length of the shortest path from vertex v to the vertex u

correct

not sure

the length of the shortest edge from vertex v to points already in the tree

the dynamic programming rules

the information about all adjacent vertices

Made by: Waqar Siddhu

In strongly connected components the component digraph is

136 page

Answer (Please select your correct option)

VuAnswers.com

necessarily cyclic

correct

necessarily acyclic

not necessary it can be both cyclic and acyclic

cyclic with some other constraints

Made by: Waqar Siddhu

Floyd-Warshall algorithm is

161

Answer (Please select your correct option)

VuAnswers.com

based on greedy approach and allow negative edges

based on divide and conquer approach and allow negative edges

based on dynamic programming approach and allow negative cycles

based on dynamic programming approach and allow negative edges

correct

Made by: Waqar Siddhu

Dijkstra's algorithm is used for

154 page

Answer (Please select your correct option)

VuAnswers.com

calculating multiple source shortest path problems

calculating Minimum spanning tree

shortest and Minimum Spanning tree both can be calculated by it

single source shortest path problems

correct

Made by: Waqar Siddhu

Kruskal's Algorithm has time complexity

149 page

Answer (Please select your correct option)

VuAnswers.com

overall $\mathcal{O}(V \log E)$

overall $\mathcal{O}(E \log V)$ for sparse graph $\mathcal{O}(V \log E)$

overall $\mathcal{O}(E \log E)$ and for sparse graph $\mathcal{O}(E \log V)$

correct

overall $\mathcal{O}(EV)$ and for sparse graph $\mathcal{O}(V^2)$

Made by: Waqar Siddhu

Bellman Ford algorithm applies relaxation to every

159 page

Bellman-Ford applies relaxation to every edge of the graph and repeats this $V - 1$ times.

Answer (Please select your correct option)

VuAnswers.com

edge of the graph and repeats exactly $v-1$ times

correct

vertex of the graph and repeats exactly $E-1$ times

edge of the graph and repeats exactly $E-1$ times

edge but use the back edges for the completion

Made by: Waqar Siddhu

In NP-problems "NP" represents

The term "NP" does not mean "not polynomial". Originally, the term meant "non-deterministic polynomial"

Answer (Please select your correct option)

VuAnswers.com

Non-deterministic Polynomials

correct

Null-polynomials

Negative Polynomials

Non-polynomials

Made by: Waqar Siddhu

The recurrence represented by $T(n) = \sum_{i=0}^n 2 + \sum_{i=0}^n i/2$ has time complexity belongs to

no idea

Answer (Please select your correct option)

VuAnswers.com

P-Class

NP-Class

Co-NP Class

Unpredictable class

Made by: Waqar Siddhu

The function having complexity $O(r^n)$ belongs to

Answer (Please select your correct option)

VuAnswers.com

- | | | |
|---|----------------|-----------------|
| <input type="radio"/> NP-Class | <u>correct</u> | <u>not sure</u> |
| <input type="radio"/> Co-Prime Class | | |
| <input type="radio"/> P-Class | | |
| <input type="radio"/> Both P and NP Classes | | |

Made by: Waqar Siddhu

3-color problem is known as _____

137

Answer (Please select your correct option)

VuAnswers.com

P

NPC

Co-NP

P and NP

correct

Made by: Waqar Siddhu

Generalize Coloring problem arises in various partitioning problems where there is a constraint

173

Answer (Please select your correct option)

VuAnswers.com

that two objects can not be assigned to the same set of partitions and is belong to NP class

correct

that two objects can not be assigned to the same set of partitions and is belong to P class

of that we can organize the different partitions in P time and NP space

of colors does not effect the classifications

Made by: Waqar Siddhu

In the 3-coloring problem, for two vertices to be in the same group, they must be not _____ to each other.

176 page

Answer (Please select your correct option)

VuAnswers.com

Apart from

Far from

Near to

Adjacent to

correct

Made by: Waqar Siddhu

Sieve Technique can be applied to solve _____

35 page

Answer (Please select your correct option)

VuAnswers.com

Selection problems

correct

Arguement problems

Dynamic problems

Greedy problems

Made by: Waqar Siddhu

If an algorithm has a complexity of $5n + \log_2(\log_2 n) + 10$ for some model of computation (some set of assumptions) and some complexity measures (such as number of comparison operations) we could say that it has complexity

no idea

Answer (Please select your correct option)

VuAnswers.com

$O(\log_2 n)$

$O(n)$

$O(3 + 1 + 3)$

$O(\log_2(\log_2 n))$

Made by: Waqar Siddhu

Search techniques of various algorithms look at _____

97 page

Answer (Please select your correct option)

VuAnswers.com

Many possible solutions

correct

Maximum 2 possible solutions

Minimum 2 possible solutions

Sorting solutions

Made by: Waqar Siddhu

Usually which type of algorithm is harder to prove the correctness?

Answer (Please select your correct option)

VuAnswers.com

Dynamic programming

Brute Force

correct

solve by comen fact.....not in the book

Greedy

Divide and conquer

Made by: Waqar Siddhu

Consider the following Huffman Tree

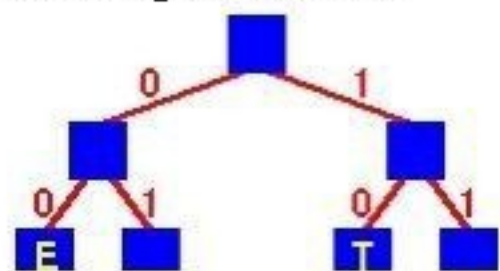

Answer (Please select your correct option)

VuAnswers.com

10 00 010

correct

011 00 010

10 00 110

11 10 110

Made by: Waqar Siddhu

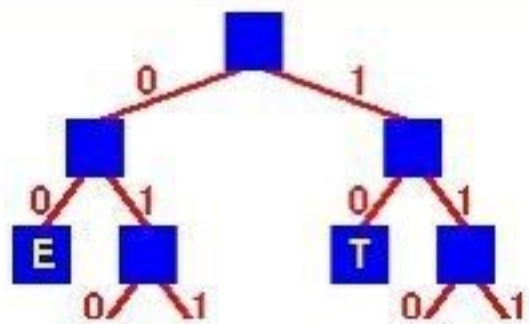

Answer (Please select your correct option)

VuAnswers.com

 10 00 010correct 011 00 010 10 00 110 11 10 110

Made by: Waqar Siddhu

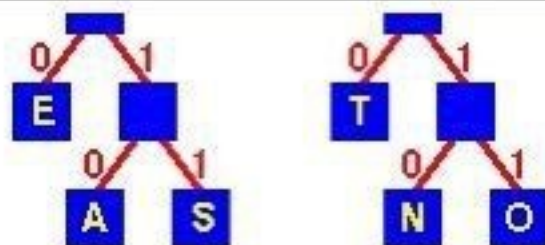

The binary code for the string "TEA" is

Answer (Please select your correct option)

VuAnswers.com

10 00 010

correct

011 00 010

10 00 110

11 10 110

Made by: Waqar Siddhu

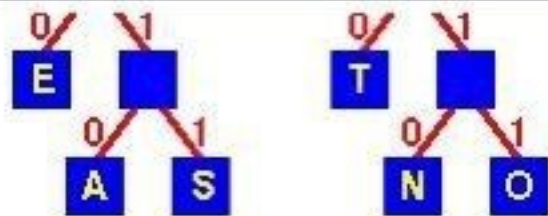

The binary code for the string "TEA" is

Answer (Please select your correct option)

VuAnswers.com

10 00 010

correct

011 00 010

10 00 110

11 10 110

Made by: Waqar Siddhu

What is generally true of Adjacency List and Adjacency Matrix representations of graphs?

Answer (Please select your correct option)

VuAnswers.com

Lists require less space than *matrices* but take longer to find the weight of an edge (v_1, v_2)

correct

Lists require less space than *matrices* and they are faster to find the weight of an edge (v_1, v_2)

Lists require more space than *matrices* and they take longer to find the weight of an edge (v_1, v_2)

Lists require more space than *matrices* but are faster to find the weight of an edge (v_1, v_2)

Made by: Waqar Siddhu

If a graph has v vertices and e edges then to obtain a spanning tree we have to delete

Answer (Please select your correct option)

VuAnswers.com

v edges.

$v - e + 5$ edges

$v + e$ edges.

None of these

correct

Made by: Waqar Siddhu

The Huffman algorithm finds a (n) _____ solution.

Answer (Please select your correct option)

VuAnswers.com

Optimal

correct

Non-optimal

Exponential

Polynomial

Made by: Waqar Siddhu

Consider the following adjacency list:

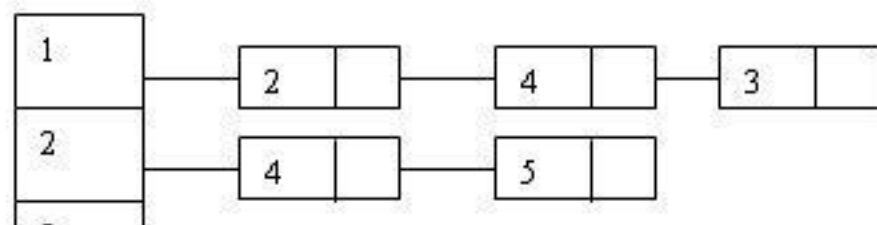

Answer (Please select your correct option)

VuAnswers.com

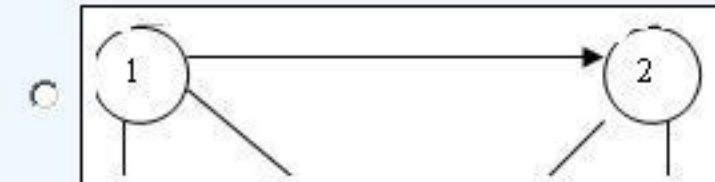
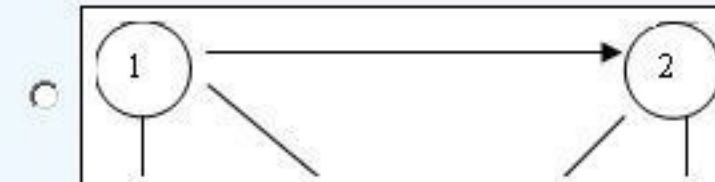
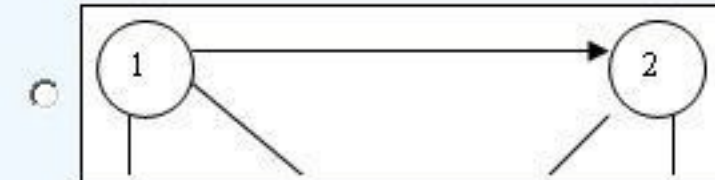
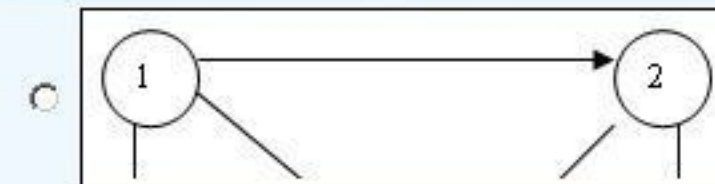

correct

Made by: Waqar Siddhu

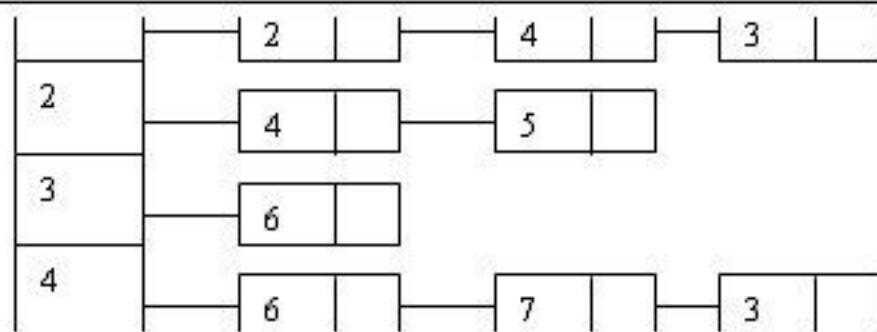

Answer (Please select your correct option)

VuAnswers.com

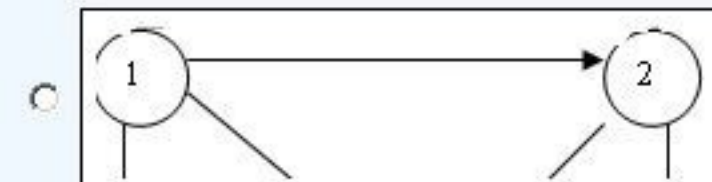
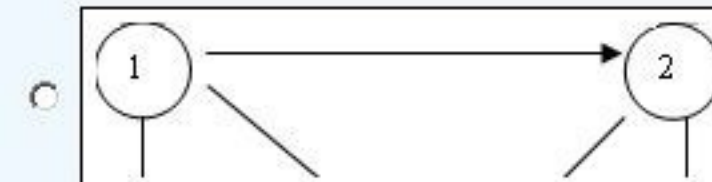
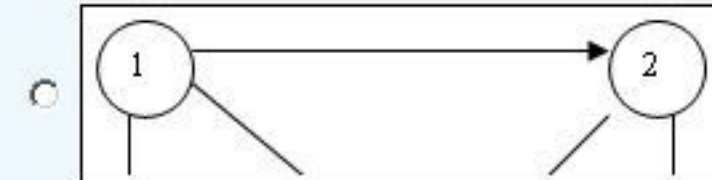

Made by: Waqar Siddhu

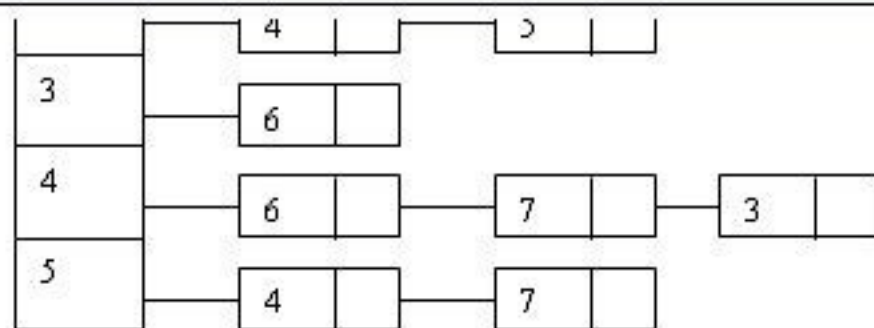

Answer (Please select your correct option)

VuAnswers.com

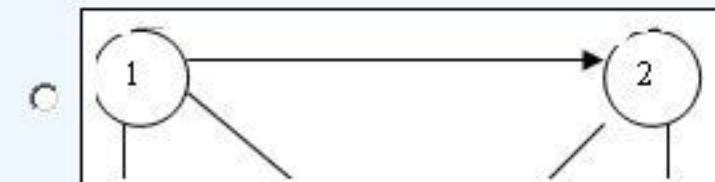
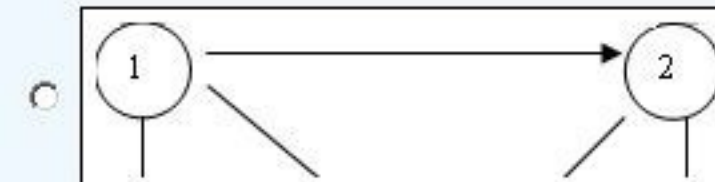
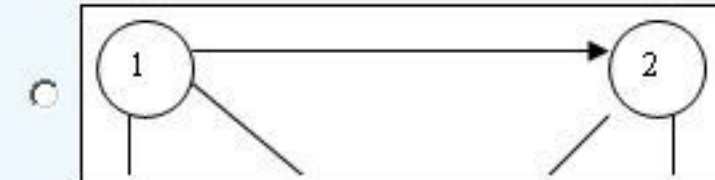
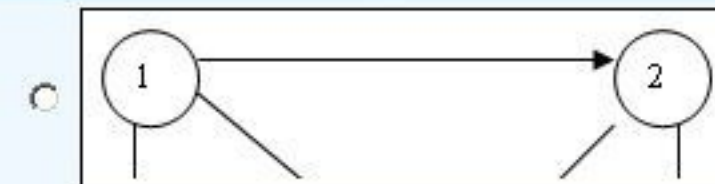

Made by: Waqar Siddhu

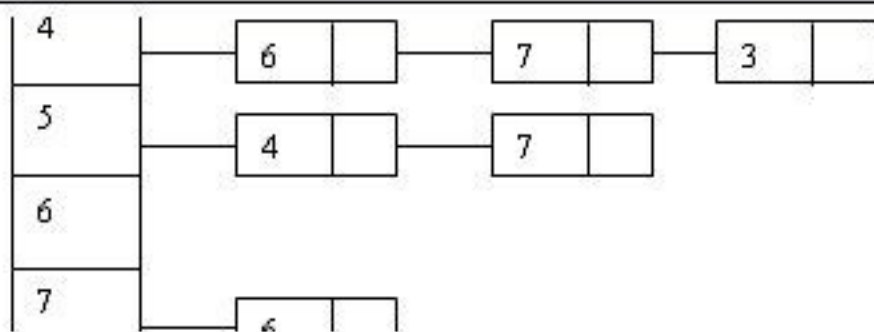

Answer (Please select your correct option)

VuAnswers.com

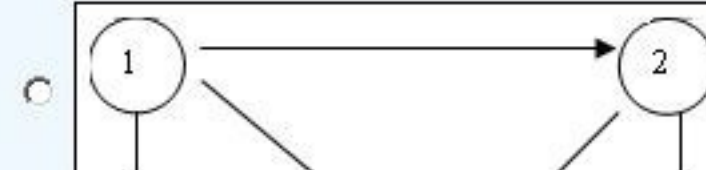

Made by: Waqar Siddhu

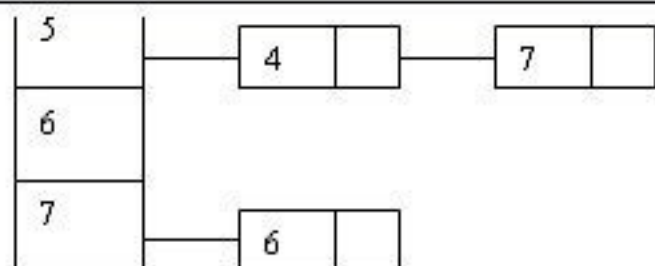

Which of the following graph(s) describe(s) the above adjacency list?

Answer (Please select your correct option)

VuAnswers.com

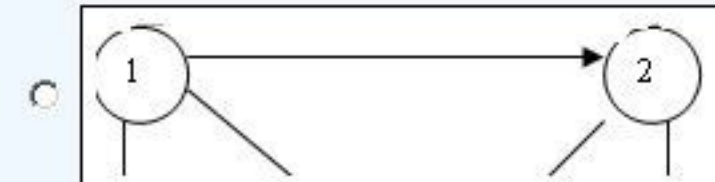
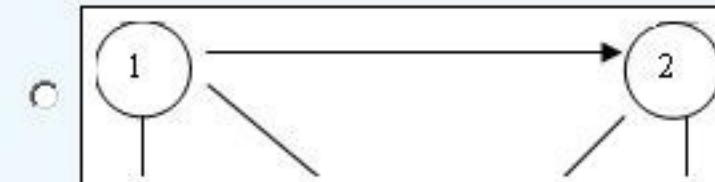
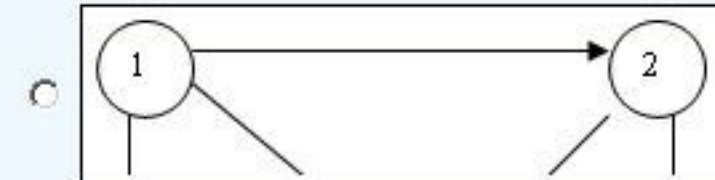
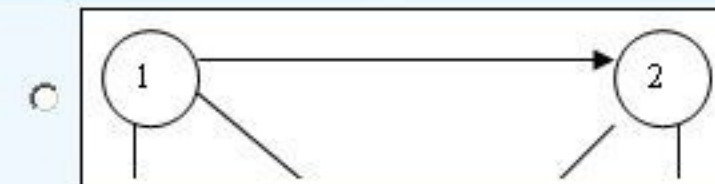

Made by: Waqar Siddhu

_____ is a graphical representation of an algorithm

Answer (Please select your correct option)

VuAnswers.com

Σ notation

Θ notation

Flowchart

correct

Asymptotic notation

Made by: Waqar Siddhu

Identify the maximal points in given set, according to 2-D maxima (the points that are NOT dominated by other points).

$\{(2,5), (4,4), (4,11), (5,1), (7,7), (7,13), (9,10), (11,5), (12,12), (13,3), (14,10), (15,7)\}$

not sure

Answer (Please select your correct option)

VuAnswers.com

$\{(7,13), (12,12), (14,10), (15,7)\}$

correct

$\{(7,7), (7,13), (9,10), (11,5), (14,10)\}$

$\{(2,5), (4,4), (4,11), (5,1), (14,10)\}$

$\{(4,4), (4,11), (7,13), (9,10), (14,10)\}$

Made by: Waqar Siddhu

What will be result of the following recurrence relation?

$$T(n) = \begin{cases} 4 & \text{if } n = 1 \\ T(n/5) + 3n^2 & \text{if } n \text{ is divisible by } 5 \end{cases}$$

Then $T(5)$ is

Answer (Please select your correct option)

VuAnswers.com

25

75

79

70

Made by: Waqar Siddhu

When we call heapify then at each level the comparison performed takes time

Answer (Please select your correct option)

VuAnswers.com

It will take $\Theta(1)$

correct

Time will vary according to the nature of input data

It can not be predicted

It will take $\Theta(\log n)$

Made by: Waqar Siddhu

Who invented Quick sort procedure?

Answer (Please select your correct option)

VuAnswers.com

Hoare

correct

Sedgewick

Mellroy

Coreman

Made by: Waqar Siddhu

The main shortcoming of counting sort is that it is useful for

The main shortcoming of counting sort is that it is useful for small integers.

71 page

Answer (Please select your correct option)

VuAnswers.com

Small Integers

correct

Small characters

Floats

None of these

Made by: Waqar Siddhu

A product of matrices is _____ if it is either single matrix or the product of two matrix products, surrounded by parentheses.

not sure

Answer (Please select your correct option)

VuAnswers.com

Fully parenthesized

correct

Partially parenthesized

Not parenthesized

None of the options

Made by: Waqar Siddhu

Maximum number of edges in a Directed Graph may be

Answer (Please select your correct option)

VuAnswers.com

- V
- $2V$
- Approximately $|V^2|$
correct
- \sqrt{V}

Made by: Waqar Siddhu

If we encode and compress text using ASCII standard each character is represented by

Answer (Please select your correct option)

VuAnswers.com

- Fixed length codeword of 4 bits
- Variable length codeword up to 4 bits
- Variable length codeword up to 8 bits
- Fixed length codeword of 8 bits.

correct

Made by: Waqar Siddhu

The Huffman Coding uses

101

Answer (Please select your correct option)

VuAnswers.com

Prefix property that code words are not matched at ends

No prefix property it has its own method to store the codes

Prefix property that no code word is prefix of any other code

correct

Prefix property that no code words at same level of tree are prefix at other levels

Made by: Waqar Siddhu

In directed graphs the cardinality of edges $|E| =$

Answer (Please select your correct option)

VuAnswers.com

Sum of out-degrees of all the vertices

Sum of in-degrees of all the vertices

First both are true

correct

There is no relation between degree of vertices and no of edges

Made by: Waqar Siddhu

A Hamiltonian cycle is a cycle

Answer (Please select your correct option)

VuAnswers.com

that visits every vertex in the graph exactly once

correct

that visits both vertex and edge exactly once

that visits all vertices without any constraint

that visits every edge in the graph exactly once

Made by: Waqar Siddhu

In generic graph traversal algorithm we

Answer (Please select your correct option)

VuAnswers.com

put vertices in the bag data structure

put edges in the bag data structure

correct

put edges in stack data structure

put vertices in the stack data structure

Made by: Waqar Siddhu

In time stamp traversal we can calculate

Answer (Please select your correct option)

VuAnswers.com

whether the graph has Cycles

correct

total number of cycles on the bases of forward edges

total number of cycles on the bases if back edges

total no of paths of certain length

Made by: Waqar Siddhu

Precedence constraint graph is

Answer (Please select your correct option)

VuAnswers.com

non acyclic directed graph

acyclic undirected graph

non acyclic undirected graph

acyclic directed graph

correct

Made by: Waqar Siddhu

In Prim's algorithm, the additional information maintained by the algorithm is

not sure

Answer (Please select your correct option)

VuAnswers.com

the length of the shortest path from vertex v to the vertex u

correct

the length of the shortest edge from vertex v to points already in the tree

the dynamic programming rules

the information about all adjacent vertices

Made by: Waqar Siddhu

Bellman Ford algorithm is for the

Answer (Please select your correct option)

VuAnswers.com

single source shortest path finding problem and does allow negative cycles

single source shortest path finding problem and does allow negative edges and negative cycles

multiple-source shortest path finding problem and does allow negative edges

correct

single source shortest path finding problem and does allow negative edges

Made by: Waqar Siddhu

Which of the following is not true about Dijkstra's algorithm?

Answer (Please select your correct option)

VuAnswers.com

The length of the shortest path to the start vertex is always zero

It can find the shortest paths to all other vertices in the same worst case time that it needs to find the shortest path to a single vertex

correct

It will work on any weighted graph with positive weights

The running time of Bellman - Ford Algorithm is greater than Dijkstra's algorithm

Made by: Waqar Siddhu

Kruskal's Algorithm is used for

Answer (Please select your correct option)

VuAnswers.com

calculating shortest path problem

calculating Minimum spanning tree

correct

shortest and Minimum Spanning tree both can be calculated by it

single source shortest path problems

Made by: Waqar Siddhu

Dijkstra's algorithm is used for

Answer (Please select your correct option)

VuAnswers.com

- calculating multiple source shortest path problems
- calculating Minimum spanning tree
- shortest and Minimum Spanning tree both can be calculated by it
- single source shortest path problems

correct

Made by: Waqar Siddhu

Kruskal's Algorithm has time complexity

Answer (Please select your correct option)

VuAnswers.com

overall $\mathcal{O}(E \log E)$ and for sparse graph $\mathcal{O}(E \log V)$

correct

overall $\mathcal{O}(EV)$ and for sparse graph $\mathcal{O}(V^2)$

overall $\mathcal{O}(V \log E)$

overall $\mathcal{O}(E \log V)$ for sparse graph $\mathcal{O}(V \log E)$

Made by: Waqar Siddhu

Bellman Ford algorithm applies relaxation to every

Answer (Please select your correct option)

VuAnswers.com

edge of the graph and repeats exactly $E-1$ times

edge but use the back edges for the completion

edge of the graph and repeats exactly $v-1$ times

correct

vertex of the graph and repeats exactly $E-1$ times

Made by: Waqar Siddhu

Complexity wise the comparison based merge and quick sort algorithms fall in

Answer (Please select your correct option)

VuAnswers.com

- Deterministic Polynomial class
- Non-Deterministic Polynomial class
- Quick sort in P class and Merge sort in NP class
- Quick sort in NP class and Merge sort in P class

Made by: Waqar Siddhu

In NP-problems "NP" represents

Answer (Please select your correct option)

VuAnswers.com

Non-deterministic Polynomials

correct

Null-polynomials

Negative Polynomials

Non-polynomials

Made by: Waqar Siddhu

Floyd-Warshall algorithm dates back to the early _____.

Answer (Please select your correct option)

VuAnswers.com

70's

90's

60's

50's

correct

Made by: Waqar Siddhu

Space used by Floyd-Warshall algorithm is

the running time is $O(n^3)$. The space used by the algorithm is $O(n^2)$.

Answer (Please select your correct option)

VuAnswers.com

$\Theta(n^4)$

$\Theta(n^3)$

$\Theta(n^2)$

correct

$\Theta(2^n)$

Made by: Waqar Siddhu

In the clique cover problem, for two vertices to be in the same group, they must be _____ each other.

176

Answer (Please select your correct option)

VuAnswers.com

Apart from

Far from

Near to

Adjacent to

correct

Made by: Waqar Siddhu

Polynomial time certificates

naipata

Answer (Please select your correct option)

VuAnswers.com

indicate there are polynomial solutions for NP -class problems

are the tools to solve the problems in P class in P time

use in reductions to verify for the NP-problems classes

use in Polynomial classes to interchange the problems

Made by: Waqar Siddhu

What is the solution to the recurrence $T(n) = T(n/2) + n$?

Answer (Please select your correct option)

VuAnswers.com

$O(\log n)$

$O(n)$

correct

$O(n \log n)$

$O(n^2)$

Made by: Waqar Siddhu

If a pseudo code is memory wise efficient then

Answer (Please select your correct option)

VuAnswers.com

Obviously it will be time wise efficient as well.

Memory wise efficient codes cannot be time wise efficient

Time wise efficient code can be memory wise efficient but vice versa is not true.

It may be memory wise efficient but not necessary

correct

Made by: Waqar Siddhu

Merge sort makes two recursive calls. Which statement is true after these recursive calls finish, but before the merge step?

Answer (Please select your correct option)

VuAnswers.com

The array elements form a heap

Elements in each half of the array are sorted amongst themselves

correct

Elements in the first half of the array are less than or equal to elements in the second half of the array

None of the given options

Made by: Waqar Siddhu

Search techniques of various algorithms look at _____

Answer (Please select your correct option)

VuAnswers.com

Many possible solutions

correct

Maximum 2 possible solutions

Minimum 2 possible solutions

Sorting solutions

Made by: Waqar Siddhu

Using ASCII standard each character is represented by a fixed length codeword of _____

Answer (Please select your correct option)

VuAnswers.com

9 bits

16 bits

8 bits

correct

32 bits

Made by: Waqar Siddhu

The Huffman encoding algorithm is a _____

Answer (Please select your correct option)

VuAnswers.com

Dynamic and greedy algorithm

Divide and conquer and greedy algorithm

Geedy algorithm.

correct

Dynamic programming algorithm

Made by: Waqar Siddhu

Breadth first search is shortest path algorithm that works

Answer (Please select your correct option)

VuAnswers.com

on un-weighted graphs

correct

on weighted graphs

on both weighted and un-weighted graphs

BFS cannot be used for shortest path problems

Made by: Waqar Siddhu

Suppose that a graph $G = (V, E)$ is implemented using adjacency lists. What is the complexity of a breadth-first traversal of G ?

Answer (Please select your correct option)

VuAnswers.com

$O(|V|^2)$

$O(|V| |E|)$

$O(|V|^2 |E|)$

$O(|V| + |E|)$

Made by: Waqar Siddhu

Non-optimal or greedy algorithm for money change takes _____

Answer (Please select your correct option)

VuAnswers.com

$O(kN)$

$O(2^k)$

$O(N)$

$O(k)$

p 99

Made by: Waqar Siddhu

The Huffman algorithm finds a (n) _____ solution.

Answer (Please select your correct option)

VuAnswers.com

Optimal

Non-optimal

Exponential

Polynomial

Made by: Waqar Siddhu

Using ASCII standard the string "abacdaacac" will be encoded with _____ bits.

Answer (Please select your correct option)

VuAnswers.com

80

160

320

100

Made by: Waqar Siddhu

Consider the string "abacdaacac" if the string is coded with ASCII codes using Huffman encoding scheme, the message length would be

Answer (Please select your correct option)

VuAnswers.com

8 bits

80 bits

Less than 50 bits

More than 50 bits

Made by: Waqar Siddhu

Random access machine or RAM is a/an

Answer (Please select your correct option)

VuAnswers.com

Machine build by Al-Khwarizmi

Mechanical machine

Electronics machine

Mathematical model

p 10

Made by: Waqar Siddhu

In order to say anything meaningful about our algorithms, it will be important for us to settle on a _____.

Answer (Please select your correct option)

VuAnswers.com

C++ program

Java program

Pseudo program

Mathematical model of computation

p 10

Made by: Waqar Siddhu

Divide-and-conquer involves breaking the problem into a small number of

Answer (Please select your correct option)

VuAnswers.com

Sub problems

p 34

Selection

pivot

Sieve

Made by: Waqar Siddhu

Quick sort procedure was invented by

Answer (Please select your correct option)

VuAnswers.com

Hoare

Sedgewick

Mellroy

Coreman

Made by: Waqar Siddhu

In Bucket sort, if there are duplicates then each bin can be replaced by a

Answer (Please select your correct option)

VuAnswers.com

Linked list p 69

Heap

Hash table

Stack

Made by: Waqar Siddhu

In in-place sorting algorithm is one that uses no _____ arrays for storage.

Answer (Please select your correct option)

VuAnswers.com

two dimensional

three dimensional

n dimensional

additional

Made by: Waqar Siddhu

A $p \times q$ matrix A can be multiplied with a $q \times r$ matrix B. The result will be a $p \times r$ matrix C. In particular, for $1 \leq i \leq p$ and $1 \leq j \leq r$,

Answer (Please select your correct option)

VuAnswers.com

$C[i, j] = \sum_{k=1}^q A[i, k]B[k, j]$ p 84

$C[i, j] = \sum_{k=1}^q A[k, i]B[k, j]$

$C[i, j] = \sum_{k=1}^q A[k, i]B[j, k]$

None of these

Made by: Waqar Siddhu

For a given chain of matrices A_1, A_2, A_3, A_4 , the product $A_1 A_2 A_3 A_4$ can be fully parenthesized in _____ distinct way(s).

Answer (Please select your correct option)

VuAnswers.com

Five

Four

Three

Two

Made by: Waqar Siddhu

Worst case running time of Quick Sort algorithm for an array with n elements is?

Answer (Please select your correct option)

VuAnswers.com

n^2

p 49

$n^{\frac{n}{2}}$

n

n^8

Made by: Waqar Siddhu

If we encode and compress text using ASCII standard each character is represented by

Answer (Please select your correct option)

VuAnswers.com

Fixed length codeword of 4 bits

Variable length codeword up to 4 bits

Variable length codeword up to 8 bits

Fixed length codeword of 8 bits.

p 99

Made by: Waqar Siddhu

The Huffman algorithm finds

Answer (Please select your correct option)

VuAnswers.com

- sometime optimal some time non optimal solution
- space wise optimal and time wise non optimal solution
- a non-optimal solution
- an optimal solution

Made by: Waqar Siddhu

The Huffman algorithm time complexity

Answer (Please select your correct option)

VuAnswers.com

Can be improved up to $O(n \log n)$

Can be improved up to $O(\sqrt{n} \log n)$

Is always $O(n^3)$

Is always $O(n^2)$

Made by: Waqar Siddhu

Using ASCII standard the string "abacdaac"

Answer (Please select your correct option)

VuAnswers.com

If we use variable code for ASCII it will be 32 bits

If we use fixed code for ASCII it will be 256 bits

If we use variable code for ASCII it will be will 64 bits

If we use fixed code for ASCII it will be 64 bits

Made by: Waqar Siddhu

Using Huffman encoding technique the string "abc" will take

Answer (Please select your correct option)

VuAnswers.com

5 bits

6 bits

24 bits

12 bits

Made by: Waqar Siddhu

Using Huffman encoding technique the string "a@\$a" will be encoded with _____ bits

Answer (Please select your correct option)

VuAnswers.com

5

6

8

Huffman encoding fail at this string

Made by: Waqar Siddhu

In fractional knapsack we sort the

Answer (Please select your correct option)

VuAnswers.com

Value per unit weight in increasing order

Weight per unit value in increasing order

Value per unit weight in decreasing order

Weight per unit value in decreasing order

Made by: Waqar Siddhu

In generic graph traversal algorithm we

Answer (Please select your correct option)

VuAnswers.com

put vertices in the bag data structure

put edges in the bag data structure

put edges in stack data structure

put vertices in the stack data structure

Made by: Waqar Siddhu

In time stamp traversal we can calculate

Answer (Please select your correct option)

VuAnswers.com

whether the graph has Cycles

total number of cycles on the bases of forward edges

total number of cycles on the bases if back edges

total no of paths of certain length

Made by: Waqar Siddhu

when the graph has relatively few edges

Answer (Please select your correct option)

VuAnswers.com

Prim's algorithm is better than Kruskal's

Kruskal's algorithm is better than Prim's

No one has priority over each other

the assumption few edges is not valid

Made by: Waqar Siddhu

Kruskal's algorithm

Answer (Please select your correct option)

VuAnswers.com

Choose the best tree edge

Choose the vertex that gives the lightest weight

Follow the dynamic programming rules for choosing edges

Choose the best non-cycle edge

Made by: Waqar Siddhu

In Prim's algorithm we use

Answer (Please select your correct option)

VuAnswers.com

Queue data structure

Priority Queue data structure

Stack data structure

Both stack and Queue data structures

Made by: Waqar Siddhu

Adding any edge to a free tree

Answer (Please select your correct option)

VuAnswers.com

- keeps it the free tree and increases the size of the tree
- creates a unique cycle
- it is not allowed to add the edge in free tree
- creates multiple cycles

Made by: Waqar Siddhu

An un-weighted graph can be considered as a graph in which every edge has

Answer (Please select your correct option)

VuAnswers.com

- no weight assigned to it
- by default weight of one unit p 153
- its own different keys of weights
- there are no such type of graphs in theory

Made by: Waqar Siddhu

Kruskal's Algorithm is used for

Answer (Please select your correct option)

VuAnswers.com

calculating shortest path problem

calculating Minimum spanning tree

shortest and Minimum Spanning tree both can be calculated by it

single source shortest path problems

Made by: Waqar Siddhu

Kruskal's Algorithm has time complexity

Answer (Please select your correct option)

VuAnswers.com

overall $\mathcal{O}(E \log E)$ and for sparse graph $\mathcal{O}(E \log V)$

overall $\mathcal{O}(EV)$ and for sparse graph $\mathcal{O}(V^2)$

overall $\mathcal{O}(V \log E)$

overall $\mathcal{O}(E \log V)$ for sparse graph $\mathcal{O}(V \log E)$

Made by: Waqar Siddhu

Bellman Ford algorithm applies relaxation to every

Answer (Please select your correct option)

VuAnswers.com

edge of the graph and repeats exactly $E-1$ times

edge but use the back edges for the completion

edge of the graph and repeats exactly $v-1$ times

vertex of the graph and repeats exactly $E-1$ times

Made by: Waqar Siddhu

All algorithms having the time complexity $O(n^{10})$ and $O(n^{100})$ fall

Answer (Please select your correct option)

VuAnswers.com

Non-Deterministic Polynomial class

Deterministic Polynomial class

$O(n^{10})$ in P class and $O(n^{100})$ in NP class

$O(n^{10})$ in NP class and $O(n^{100})$ in P class

Made by: Waqar Siddhu

In NP-problems "NP" represents

Answer (Please select your correct option)

VuAnswers.com

Non-deterministic Polynomials

Null-polynomials

Negative Polynomials

Non-polynomials

Made by: Waqar Siddhu

Space used by Floyd-Warshall algorithm is

Answer (Please select your correct option)

VuAnswers.com

$\Theta(n^4)$

$\Theta(n^3)$

$\Theta(n^2)$

p 164

$\Theta(2^n)$

Made by: Waqar Siddhu

If a problem is NP-complete

Answer (Please select your correct option)

VuAnswers.com

there is no relation between NP and NP-complete

it can be solved in P time

it must be in P

it must also be in NP

Made by: Waqar Siddhu

If a problem "S" is NP- complete it must be

Answer (Please select your correct option)

VuAnswers.com

NP and NP-hard

NP not necessarily NP-Hard

NP-hard means it is NP complete as well

in P and NP

Made by: Waqar Siddhu

In the 3-coloring problem, for two vertices to be in the same group, they must be not _____ to each other.

Answer (Please select your correct option)

VuAnswers.com

Apart from

Far from

Near to

Adjacent to

Made by: Waqar Siddhu

Algorithm's essential elements are

Answer (Please select your correct option)

VuAnswers.com

- Step wise solution
- Stepwise solution and finite time
- Step wise solution finite inputs
- Stepwise approach in which time and memory does not matter.

Made by: Waqar Siddhu

Search techniques of various algorithms look at ____

Answer (Please select your correct option)

VuAnswers.com

Many possible solutions

Maximum 2 possible solutions

Minimum 2 possible solutions

Sorting solutions

Made by: Waqar Siddhu

Which traversal technique is look like propagating wave-front outward

Answer (Please select your correct option)

VuAnswers.com

Generic Traversal

Breadth First Traversal

p 117

Depth First Traversal

Time Stamp Traversal

Made by: Waqar Siddhu

For More Solutions or Short Lectures (Playlist) Visit our Youtube Channel

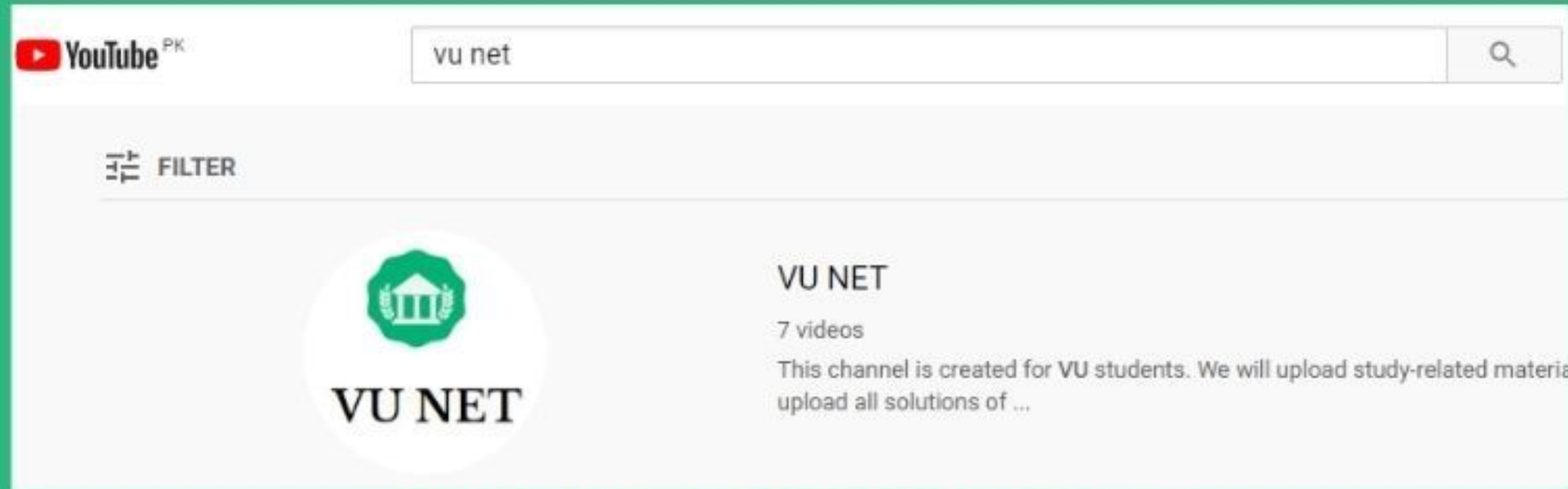

VUNET.BLOGSPOT.Com